

FRESCOPRO

TASTE LIFE OUTDOORS



TASTE LIFE OUTDOORS

Our team is a collective of designers and craftsmen with a passion for all things alfresco. With over 25 years experience in outdoor living, design and sourcing - We are FrescoPro.

Bringing a uniquely fresh and professional approach to outdoor kitchens for our clients, we work alongside homeowners, architects and developers to create luxury outdoor entertaining areas.

Long established distributors of some of the world's leading and most innovative barbecue brands, we are well placed to provide a system for the ultimate outdoor kitchen. Our kitchens grace outdoor spaces across the globe with clients in Europe, The Middle East, Australasia and North America.

So, whether it's an urban roof garden, suburban terrace or a rural mansion, we will draw on our years of design, construction and product knowledge to deliver an alfresco space that you will be proud of for many years to come.

In these pages, we bring you the best of what we have learnt over the years. Six stunning and durable kitchen packages in a choice of colours and materials. No expensive landscape design fees or architect drawings required to achieve the timeless style of a FrescoPro kitchen.

FRESCOPRO



CANBERRA

The Canberra is ideal where space is at a premium or if you are simply looking for a compact and stylish outdoor kitchen look. Featuring the essential barbecue, fridge and workspace you need, this is a fantastic package and comes with plenty of storage space for your essentials.

Our revolutionary framing systems allow us to install a great outdoor kitchen quickly and easily. Faster, cleaner and free of the complexities and hassles of traditional joinery or brick and block construction methods.



Hardwearing and timeless beauty of 20mm black granite. Alternative surfaces are available upon request.

Pictured specification (F-C4GA-12840S)

- 4 Burner Module & S3000S BBQ (stainless cook pack)
- Single Fridge
- Single Door Module
- 20mm Nero Absoluto Granite Worktops and 3mm Black ACP Door Skins





ESPERANCE

The Esperance package features the full kitchen suite. Beautifully proportioned and with generous workspace, this configuration brings you all the benefits of Canberra but adds the kitchen sink and our specially sourced single lever tap.

All FrescoPro packages use our patented aluminium framing system with no welding, cutting or bending required. Once assembled, our modules are plum square and level every time. All our frames are backed with a 25 Year Anti-corrosion Guarantee.

A great range of colour finishes to create the perfect outdoor kitchen design.

Pictured specification
(F-C5GA-12850S)

- 5 Burner Module & S3000S BBQ (stainless cook pack)
- Single Fridge
- Double Door Module
- Sink & Tap
- 20mm Nero Absolute Granite Worktops and 3mm Anthracite ACP Door Skins



Classic Aluminium Composite - Silver



Premium Dekton - Sirius



AUGUSTA

When the gatherings get large and the need for workspace is paramount you could do far worse than specify the Augusta package. Masses of worktop combined with your kitchen essentials and a double door 190 litre fridge to keep the guests well refreshed!

No footings required as our adjustable feet allow for a fall in your chosen location. You'll need a hard standing to allow easy installation of doors, drawers, sinks, appliances, wiring and plumbing if required.



BeefEater tropicalised outdoor rated fridges included in every package for style and convenience when entertaining.

Pictured specification (F-A6DA-BSH158SA)

- 6 Burner Module & Proline Roaster BBQ
- Double Fridge
- Double Door Module
- Sink & Tap
- 20mm Nero Absoluto Granite Worktops and 3mm Anthracite ACP Door Skins





BORONIA

Where space is no object and size really matters, you need look no further than Boronia. Lots of storage space, worktop and all the trimmings make this FrescoPro package a majestic centrepiece to grace any outdoor space in the world.

FrescoPro structures are designed to hold hundreds of kilos of stone and appliances. Their inherent strength and durability give structural integrity in all environments ensuring they'll stand the test of time.

Our flexible grill base modules house the award-winning BeefEater Barbecue Proline™ and Signature™ ranges.

Pictured specification (F-B5GA-12850S)

- 5 Burner Module & S3000S BBQ (stainless cook pack)
- Single Fridge / Single Door Module c/w Single Fridge
- Double Door Module
- Sink & Tap
- 20mm Nero Absolute Granite Worktops and 3mm Silver ACP Door Skins



Proline™ 6 Burner Barbecue



Signature™ 4 Burner Barbecue



FREMANTLE

For the ultimate outdoor kitchen, we recommend the Fremantle. Double fridge, triple cabinet, barbecue of your choice and, of course, the kitchen sink. Measuring up to 3.8 metres, this configuration is a timeless and beautiful showstopper.

Our framing system is designed with Aluminium side walls and shelves giving you a perfect storage space for all the kit you'll be using with your kitchen. Strong, durable and stylish as you'd expect from FrescoPro.



Stylish and durable anodized aluminium door and drawer frames come with a **5 Year Guarantee**.



Pictured specification (F-F4GA-12840S)

- 4 Burner Module & S3000S BBQ (stainless cook pack)
- Single Door Module
- Double Fridge
- Double Door Module
- Sink & Tap
- 20mm Nero Absoluto Granite Worktops and 3mm Black ACP Door Skins



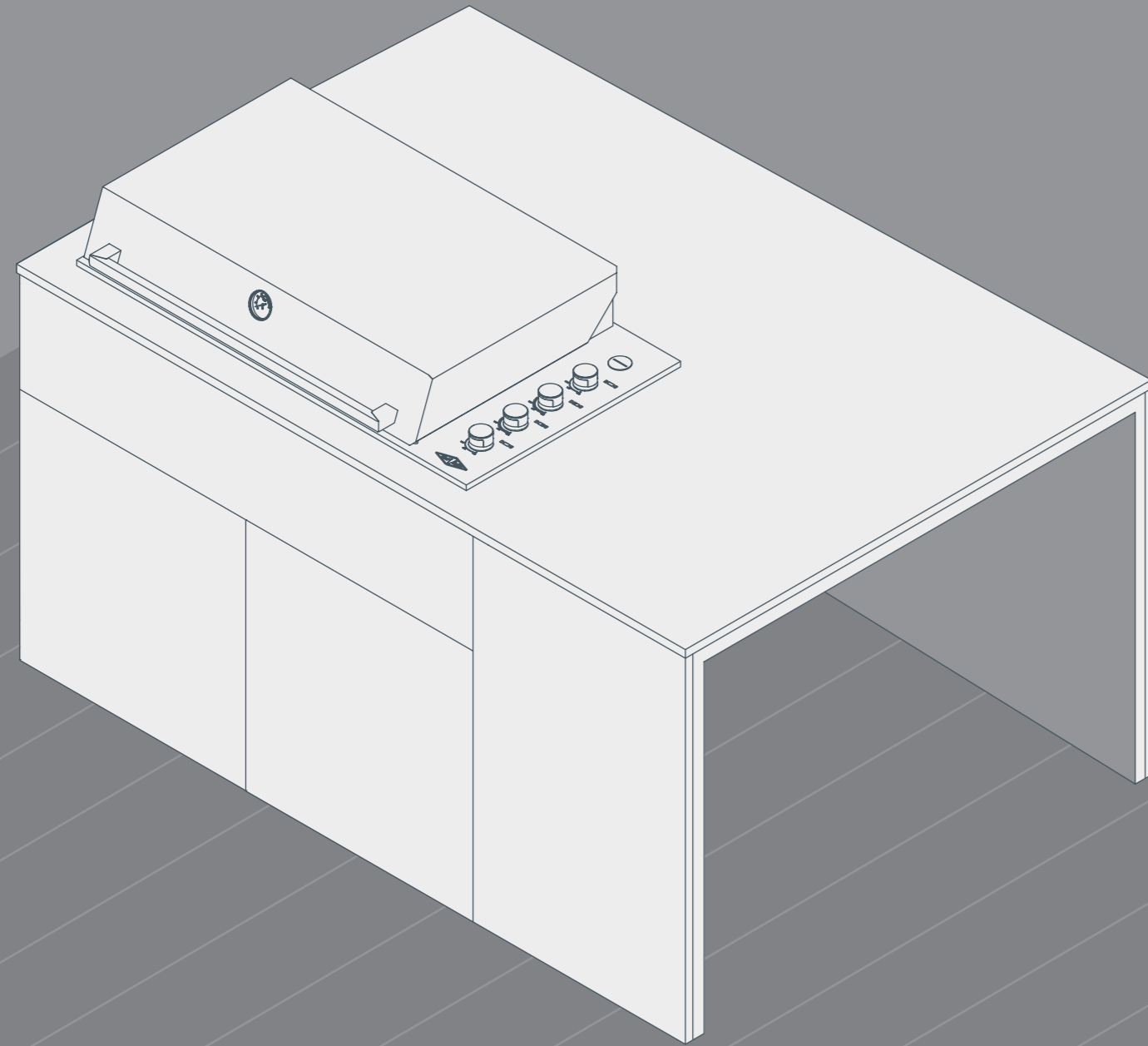

KUBE

The cupboards, drawers and back panels are made from coloured aluminium ensuring durability and easy maintenance. Backed with a **5 Year Guarantee**.

- BeefEater Proline™ 6 burner barbecue
- BeefEater Tropicalised Outdoor Refrigerator - 120 litre
- FrescoPro extruded aluminium Framing System
- Extruded aluminium door frames with soft close feature
- 20mm Solid Granite or Dekton Worktop and Waterfall End Panels

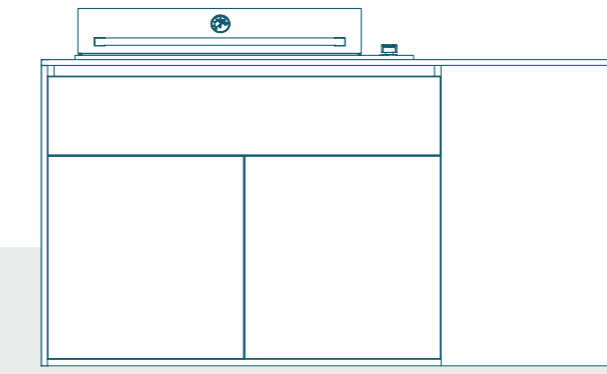

Proline™ 6 Burner
1170mm

Side Panel
660mm



Bar End
1325mm

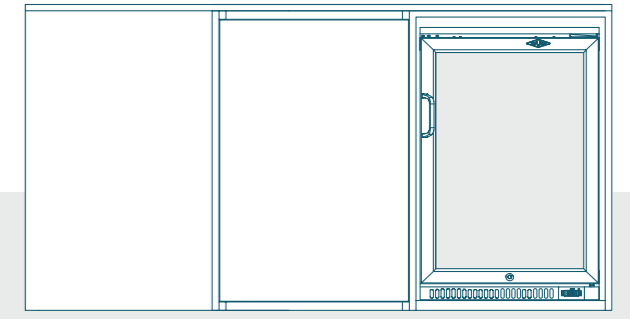

Side Panel
660mm

1 Door with Single Fridge Back
1170mm

CANBERRA

- Choice of BeefEater Signature™ 4 burner + 5 burner / Proline™ 6 burner barbecues
- BeefEater Tropicalised Outdoor Refrigerator - 120 litre
- FrescoPro extruded aluminium Framing System
- Extruded aluminium door frames with soft close feature
- 20mm Solid Granite or Dekton Worktop and Waterfall End Panels
- Includes Rear Panel Cladding



BeefEater Proline™ 6 Burner Barbecue

width 1053mm | depth 540mm



2345mm

BeefEater Signature™ 4 Burner Barbecue

width 828mm | depth 520mm



2065mm



BeefEater Signature™ 5 Burner Barbecue

width 985mm | depth 520mm

670mm



308mm
492mm
with lid up

935mm
+ 15-35mm
levelling feet

2210mm

ESPERANCE

- Choice of BeefEater Signature™ 4 burner + 5 burner / Proline™ 6 burner barbecues
- BeefEater Tropicalised Outdoor Refrigerator - 120 litre
- FrescoPro extruded aluminium Framing System
- Extruded aluminium door frames with soft close feature
- 20mm Solid Granite or Dekton Worktop and Waterfall End Panels
- Includes Rear Panel Cladding



BeefEater Proline™ 6 Burner Barbecue

width 1053mm | depth 540mm

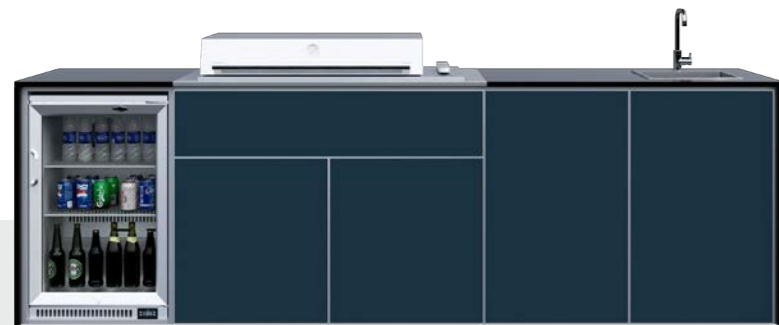

2945mm

BeefEater Signature™ 4 Burner Barbecue

width 828mm | depth 520mm



2665mm



BeefEater Signature™ 5 Burner Barbecue

width 985mm | depth 520mm

670mm



2810mm

308mm
492mm
with lid up

935mm
+ 15-35mm
levelling feet

SPECIFICATIONS

AUGUSTA

- Choice of BeefEater Signature™ 4 burner + 5 burner / Proline™ 6 burner barbecues
- BeefEater Tropicalised Outdoor Refrigerator - 190 litre
- FrescoPro extruded aluminium Framing System
- Extruded aluminium door frames with soft close feature
- 20mm Solid Granite or Dekton Worktop and Waterfall End Panels
- Includes Rear Panel Cladding



BeefEater Proline™ 6 Burner Barbecue

width 1053mm | depth 540mm



3255mm

BeefEater Signature™ 4 Burner Barbecue

width 828mm | depth 520mm



2975mm

BeefEater Signature™ 5 Burner Barbecue

width 985mm | depth 520mm

670mm



3120mm

308mm
492mm
with lid up

935mm
+ 15-35mm
levelling feet



SPECIFICATIONS

BORONIA

- Choice of BeefEater Signature™ 4 burner + 5 burner / Proline™ 6 burner barbecues
- BeefEater Tropicalised Outdoor Refrigerator - 120 litre
- FrescoPro extruded aluminium Framing System
- Extruded aluminium door frames with soft close feature
- 20mm Solid Granite or Dekton Worktop and Waterfall End Panels
- Includes Rear Panel Cladding

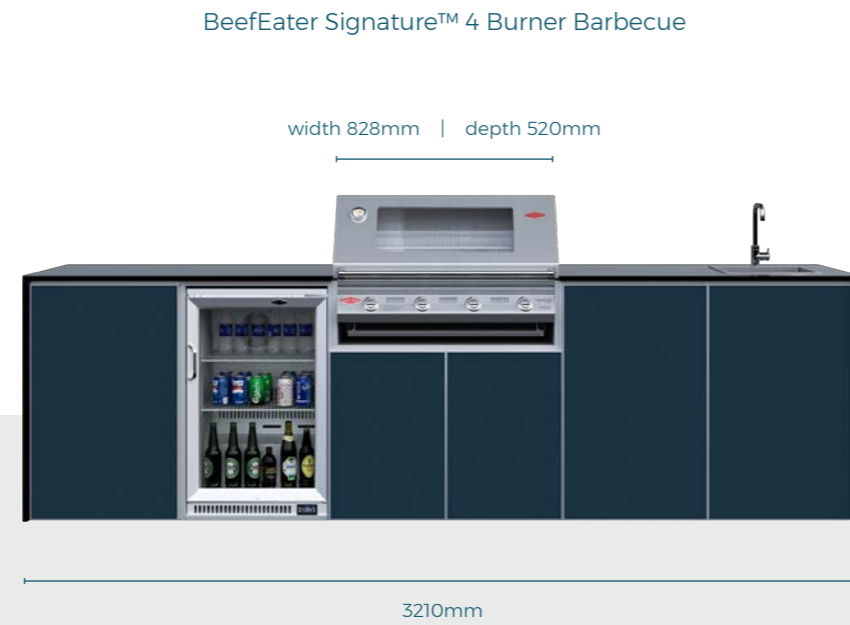

FREMANTLE

- Choice of BeefEater Signature™ 4 burner + 5 burner / Proline™ 6 burner barbecues
- BeefEater Tropicalised Outdoor Refrigerator - 190 litre
- FrescoPro extruded aluminium Framing System
- Extruded aluminium door frames with soft close feature
- 20mm Solid Granite or Dekton Worktop and Waterfall End Panels
- Includes Rear Panel Cladding

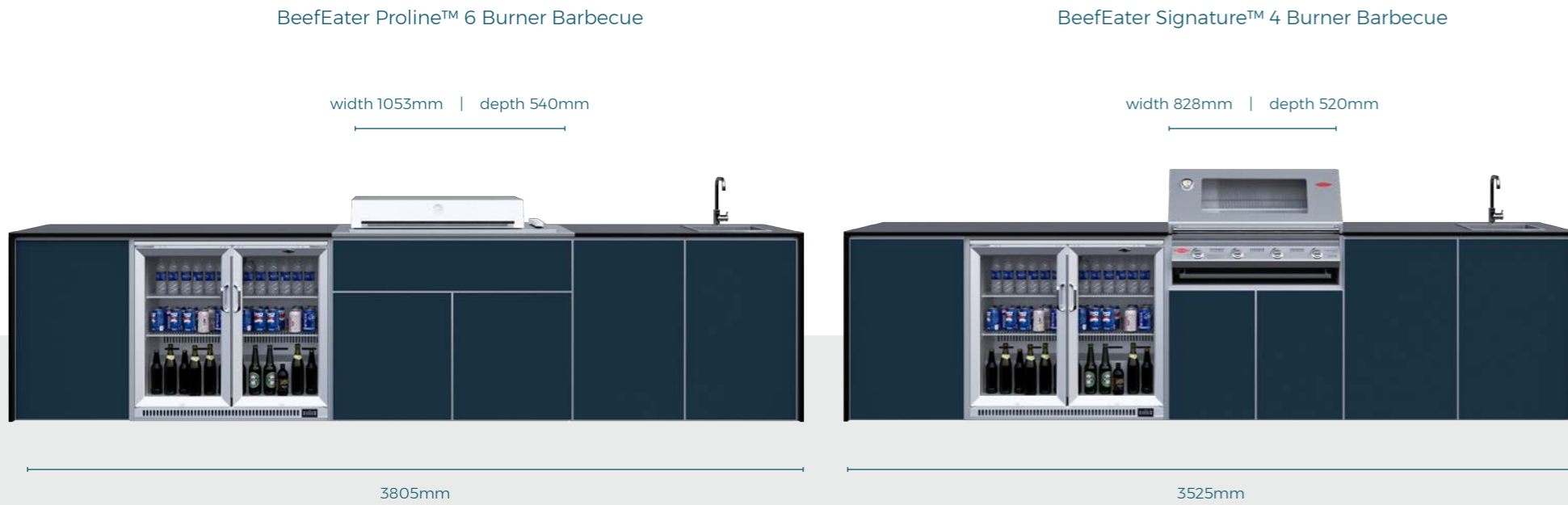

MAKE IT YOUR OWN

In addition to the packages we have put together in this brochure, we are pleased to assist you with any configuration you want.

The page opposite shows all of the modules that we offer so you really can build your own.

5 Easy steps to making your own -

1. Select the modules that you want to have in your kitchen from the list on page 25.
2. Choose the barbecue and fridge that you want in your kitchen from pages 28 & 29 or, if you prefer, tell us which other brand and appliance you want to try and include in your kitchen.
3. Note the material and colour of your worktops and door skins from the selection on page 27.
4. List any accessories that you might want, such as a Glow Charcoal barbecue or a BeefEater Side Burner. Details can be found on pages 29 & 30.
5. Email or call us with your list and we'll be happy to take care of your requirements by confirming the suitability of your configuration.



FrescoPro MODULES

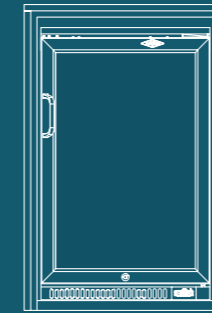
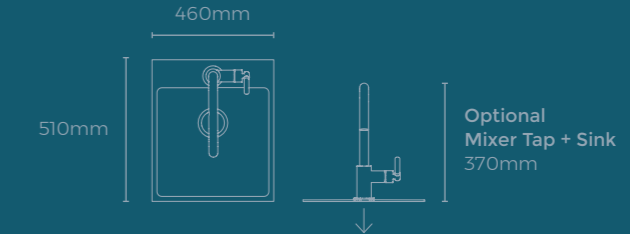

Single Fridge Module
605mm

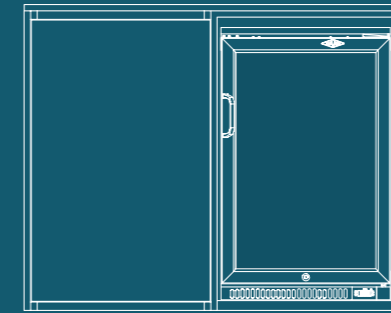

1 Door with Single Fridge Module
1150mm

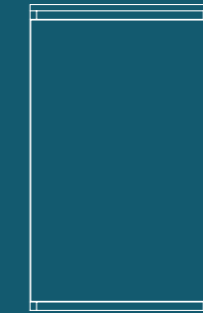

1 Door Module
550mm

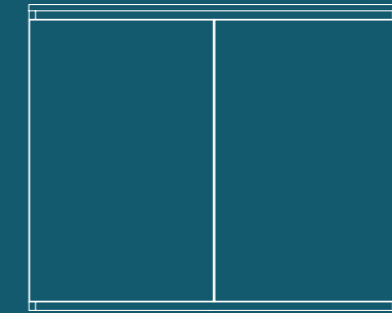

Split Module with 2 Doors Module
1150mm

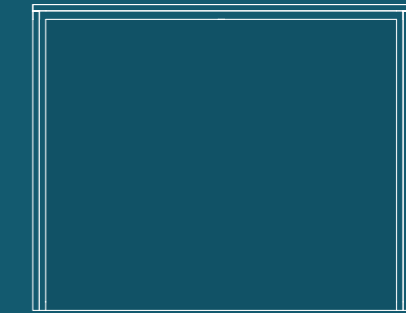

Bar End Module
1285mm

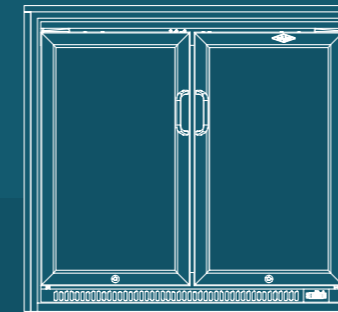

Double Fridge Module
915mm

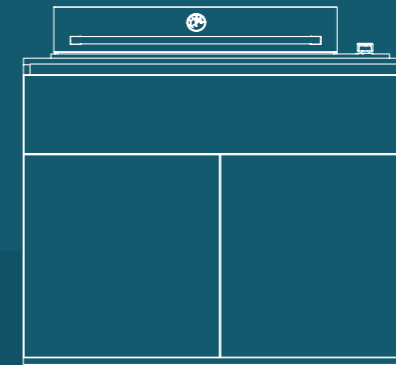

Proline™ 6 Burner Module
1150mm

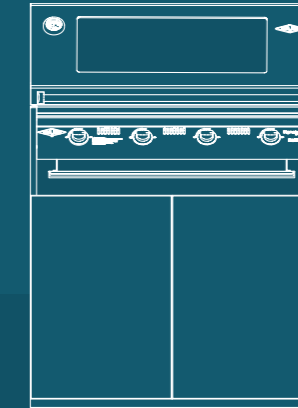

Signature™ 4 Burner Module
870mm

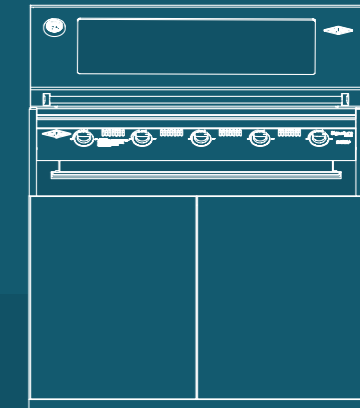

Signature™ 5 Burner Module
1015mm



CREATING YOUR KITCHEN

In this brochure you will see a selection of our recommended packages. Whilst they vary in size, finish and selected appliance, they all have the same fundamental structure and finishing system in use as you will see in our step by step explanation.



BUILT TO LAST

At the heart of every FrescoPro kitchen you'll find a series of our ingenious aluminium framing modules. The grooved design of our extrusion is the basis for our 'clip and fix' smarts which enable the simple application of high quality finishes and world leading appliances.

The light weight properties of aluminium combined with its exceptional strength, durability and corrosion resistance make it an ideal material for what comes next.

Patented easy fix system to enable mess free installation

Extruded aluminium frame for strength and durability

25 Year Anti-corrosion Guarantee for peace of mind



25 YEAR ANTI-CORROSION GUARANTEE

THE CHOICE IS YOURS

Once our framing system has been assembled, its time to add the doors, for which we use our preferred aluminium frame. Easily fitted and levelled with our specially selected Hettich hinges we tailor the look to suit your taste in colour and design by adding 'skins'.



Our standard skin is the smooth and durable elegance of aluminium composite with choices of black, anthracite, silver or white.

For the ultimate in design and style we also offer Dekton skins in four carefully selected 4mm finishes - Laos, Trillium, Sirius and Sirocco.

DOOR SKINS

Classic Aluminium Composite

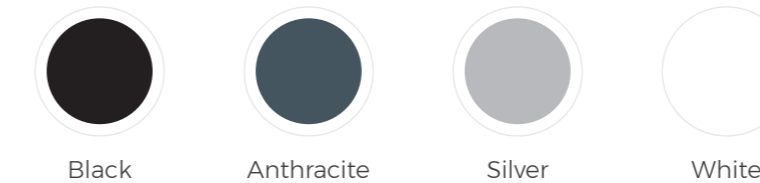

Premium Dekton

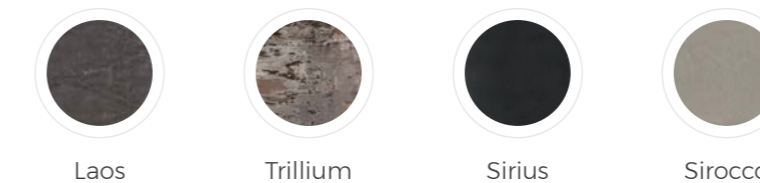

With the structure now firmly in place and the front of your kitchen complete with your chosen finish, its time to apply the all important worktops and waterfalls (end panels). Just like your kitchen indoors, these surfaces will be in constant use during your outdoor cooking experience so important they should be both durable and attractive. As with the materials used to this point, our worktops are of the finest quality too.

Most of our customers go for the timeless quality of granite with its unique grains and excellent outdoor stability - Nero Absoluto is the favourite but our lighter colour option of Steel Grey suits some folks better. Once again, we offer the ultimate finish in Dekton with its exceptional heat resistance, UV stability and maintenance simplicity in the darker finish of Sirius or a lighter hued Sirocco.

WORKTOPS + WATERFALLS

Classic Granite

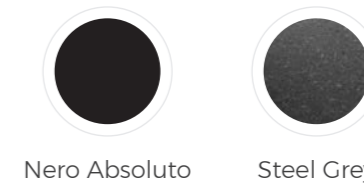

Premium Dekton

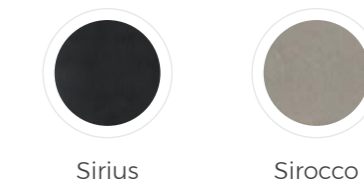

WORKING WITH THE BEST

Your kitchen is now ready for it's centrepiece appliances. Our partner brand is Australian backyard icon BeefEater but your FrescoPro kitchen can be tailored to accommodate many leading quality barbecue brands if you prefer.

We use BeefEater for their reputation for producing high powered gas barbecues offering long warranties, a range of material finishes and the versatility of LPG or NG application.

As well as the barbecue you'll need a fridge to complete the outdoor kitchen ensemble and once again we turn to BeefEater for a choice between the single door 120 litre or double door 190 litre glass door options.



BeefEater Proline™ Roasting Hood
6 Burner Barbecue
BSH158SAEUGB

FEATURED BARBECUES



BeefEater Signature™ 3000S
4 Burner Barbecue
12840S - Stainless Steel Cook Pack



BeefEater Signature™ 3000S
5 Burner Barbecue
12850S - Stainless Steel Cook Pack

BARBECUES + FRIDGES



BeefEater Signature™ 3000E
4 Burner Barbecue
19942



BeefEater Signature™ 3000E
5 Burner Barbecue
19952



BeefEater Signature™ 3000S
4 Burner Barbecue
12840 - Cast Iron Cook Pack



BeefEater Signature™ 3000S
5 Burner Barbecue
12850 - Cast Iron Cook Pack



BeefEater Proline™ Roasting Hood
6 Burner Barbecue
BSH158SAEUGB



BeefEater Proline™ Flat lid
6 Burner Barbecue
BSL158SAEUGB



BeefEater Proline™ Flat lid
Side Burner
BSW318SAEUGB



BeefEater Outdoor Bar Fridge
Single Door - 120 litre
28130



BeefEater Outdoor Bar Fridge
Double Door - 190 litre
28200

COVERS



BeefEater Signature™ 4 Burner
Barbecue Cover
94494



BeefEater Signature™ 5 Burner
Barbecue Cover
94495



BeefEater Proline™ Roasting Hood
Barbecue Cover
BACS200A



BeefEater Proline™ Flat lid
Barbecue Cover
BACS201A



BeefEater Proline™ Flat lid
Side Burner Cover
BACS202A



ACCESSORIES + UPGRADES

With your kitchen now basically complete, it's time to consider those final finishing touches. As well as the main gas barbecue in your FrescoPro you may wish to add other methods of cooking to increase your range of barbecue skills and enjoyment.

Glow Charcoal is an innovative solid fuel insert sourced from our Dutch partner brand oneQ. Easily mounted in the framing system, this stunning addition gives you the option for cooking over charcoal from scratch or simply finishing your food there for that authentic barbecue taste. Accessories including a kebab set and chopping board are available and there is even an adaptor kit to enable the use of a mini Kamado.

Proline Side Burner is a popular choice for regular outdoor entertainers wanting to prepare the whole meal alfresco. This high powered quad burner is the ideal accessory for cooking vegetables, sauces, stir fries and more.



You may have noticed that all but one of our recommended packages come with a sink and tap. This is because we believe it is an essential component on all but the smallest of outdoor kitchens. It finishes the classic hot, cold, wet, dry formula that are the essence of every household kitchen. Made from 316 grade stainless steel these 400 x 400 sinks and carefully selected single lever taps are a terrific addition to your FrescoPro. If you prefer your kitchen without a sink and tap then please ask and we will happily remove it from your package.

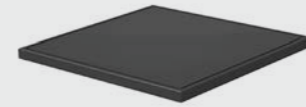

Glow BBQ Table
Polyethylene Chopping Board
F-OQ-800901740



Glow BBQ Close
Stainless Steel Lid
F-OQ-900901940

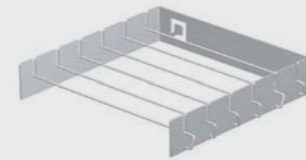

Glow BBQ Kebab Set
F-OQ-900901905



Glow BBQ Dome
Adaptor for Mini Kamado
F-OQ-900901941



Glow Charcoal BBQ
F-OQ-900901710



Glow BBQ Built In Socket
Required to house Glow BBQ
F-OQ-900901750



Glow BBQ Built In Adaptor
Required to house Glow BBQ
F-OQ-900901751

THE FINAL FLOURISH

The final point we wish to make in this guide to your perfect outdoor kitchen is that FrescoPro is adaptable. We have shared our recommended packages based on years of talking with our clients and understanding their needs.

The basic structure, the finishes and the accessories we offer give a wide range of options covering the needs of most outdoor kitchen developments.

But we know there is always innovation - new designs, new ideas and different spaces to fill. That is why we offer a consultation service to our customers and will do our best to accommodate your requirements be it by design, appliance or finish.

We are FrescoPro.



Make it your own

See our 'Make it your own' guide on pages 24 + 25



TASTE LIFE OUTDOORS

FRESCO PRO

+44 (0)1252 235776

info@frescopro.co.uk

Showroom by appointment

FrescoPro Ltd, Unit 9, LDL Business Centre, Station Road West, Ash Vale GU12 5RT

frescopro.co.uk